

# OBSOLETE

## Electronic pressure switch with display Model PSD-30, standard version Model PSD-31, with flush diaphragm

WIKA data sheet PE 81.67



### Applications

- Machine tools
- Hydraulics and pneumatics
- Pumps and compressors
- Machine building

### Special features

- Easily readable, robust display
- Intuitive and fast setup
- Easy and flexible mounting configurations



Electronic pressure switch, model PSD-30

### Description

#### Award-winning in design and functionality

The successful design and the excellent functionality of the WIKA switch family were already confirmed by winning the “iF product design award 2009” for the PSD-30 pressure switch.

The robust LED display has been designed using 9 mm high characters (the largest possible) and with a slight incline in order to make reading the pressure as easy as possible from a long way off. A 14-segment display has been used, since it represents text very well.

The 3-key operation makes simple, intuitive menu navigation possible, with no need for additional assistance. The menu navigation conforms to the latest VDMA standard.

The VDMA standard for fluid sensors (24574-1, part 1 - pressure switches) has the aim of simplifying the use of pressure switches by standardising menu navigation and display.

The control keys have been designed as large as possible and are arranged ergonomically to ensure fast and easy adjustments. Operation without any additional assistance is made easier through the tactile feedback.

#### Customised installation

The installation of the PSD-30 and PSD-31 can be flexibly adapted to the individual mounting situation. Due to the almost unlimited rotation of the display and case by more than 300°, the display can be adjusted independently of the electrical connection. The display can thus always be aligned to face the operator, and the M12 x 1 connection positioned to suit the desired cable routing.

#### High quality

During development of the WIKA switch family a high value was placed on a robust design and the selection of appropriate materials suited to machine-building applications. For this reason the case and the threaded connection of the electrical connector are made from stainless steel. Overwinding or tearing off the connector is therefore virtually impossible.

#### IO-Link 1.1

With the optional output signal in accordance with the IO-Link communication standard, the PSD-30 and PSD-31 allow a fast integration into modern automation systems. IO-Link offers an even faster installation, parameterisation and higher functionality of the PSD-30 and PSD-31.

## Measuring ranges

Gauge pressure								
bar	0 ... 1 <sup>1)</sup>	0 ... 1.6 <sup>1)</sup>	0 ... 2.5	0 ... 4	0 ... 6	0 ... 10	0 ... 16	0 ... 25
	0 ... 40	0 ... 60	0 ... 100	0 ... 160	0 ... 250	0 ... 400	0 ... 600	
psi	0 ... 15 <sup>1)</sup>	0 ... 25 <sup>1)</sup>	0 ... 30 <sup>1)</sup>	0 ... 50	0 ... 100	0 ... 160	0 ... 200	0 ... 300
	0 ... 500	0 ... 1,000	0 ... 1,500	0 ... 2,000	0 ... 3,000	0 ... 5,000	0 ... 8,000	

Absolute pressure								
bar	0 ... 1 <sup>1)</sup>	0 ... 1.6 <sup>1)</sup>	0 ... 2.5	0 ... 4	0 ... 6	0 ... 10	0 ... 16	0 ... 25
psi	0 ... 15 <sup>1)</sup>	0 ... 25 <sup>1)</sup>	0 ... 30 <sup>1)</sup>	0 ... 50	0 ... 100	0 ... 160	0 ... 200	0 ... 300

Vacuum and +/- measuring range								
bar	-1 ... 0 <sup>1)</sup>	-1 ... +0.6 <sup>1)</sup>	-1 ... +1.5	-1 ... +3	-1 ... +5	-1 ... +9	-1 ... +15	-1 ... +24
psi	-14.5 ... 0 <sup>1)</sup>	-14.5 ... +15 <sup>1)</sup>	-14.5 ... +30	-14.5 ... +50	-14.5 ... +100	-14.5 ... +160	-14.5 ... +200	-14.5 ... +300

1) Not available for PSD-31.

The given measuring ranges are also available in kg/cm<sup>2</sup>, kPa and MPa.

Special measuring ranges between 0 ... 1 and 0 ... 600 bar (0 ... 15 bis 0 ... 8,000 psi) are available on request.

Special measuring ranges have a reduced long-term stability and increased temperature errors.

### Overload safety

The overload safety is based on the sensor element used. Depending on the selected process connection and sealing, restrictions in overload safety can result.

- 2 times
- 1.7 times for the relative pressure measuring ranges 160 psi, 1,000 psi and 1,500 psi

### Vacuum-tight

Yes

### Display

14-segment LED, red, 4-digit, 9 mm (0.35 inch) character size

Display can be turned electronically through 180°

Update (adjustable): 100, 200, 500 or 1,000 ms

## Output signals

Switching output		Analogue signal
SP1	SP2	
PNP	-	4 ... 20 mA (3-wire)
PNP	-	DC 0 ... 10 V (3-wire)
PNP	PNP	-
PNP	PNP	4 ... 20 mA (3-wire)
PNP	PNP	DC 0 ... 10 V (3-wire)

Optionally also available with an NPN instead of a PNP switching output

### IO-Link, version 1.1 (option)

IO-Link is optionally available for all output signals. With the IO-Link option, switching output SP1 is always PNP

### Zero offset adjustment

max. 3 % of span

### Switching thresholds

Switch point 1 and switch point 2 are individually adjustable

### Switching functions

Normally open, normally closed, window, hysteresis  
Freely adjustable

### Switching voltage

Power supply - 1 V

### Switching current

- without IO-Link: max. 250 mA
- with IO-Link: SP1 max. 100 mA  
SP2 max. 250 mA

### Settling time/response time

Analogue signal: 3 ms  
Switching output: ≤ 10 ms (20 ms with IO-Link)

### Load

Analogue signal 4 ... 20 mA: ≤ 0.5 kΩ  
Analogue signal DC 0 ... 10 V: > 10 kΩ

### Service life

100 million switching cycles

## Voltage supply

### Power supply

DC 15 ... 35 V

### Current consumption

Switching outputs with

- Analogue signal 4 ... 20 mA: 70 mA
- Analogue signal DC 0 ... 10 V: 45 mA
- without analogue signal: 45 mA

IO-Link option causes a deviating current consumption

### Total current consumption

- without IO-Link: max. 600 mA including switching current
- with IO-Link: max. 450 mA including switching current

## Accuracy specifications

### Accuracy, analogue signal

≤ ±1.0 % of span

Including non-linearity, hysteresis, zero offset and end value deviation (corresponds to measured error per IEC 61298-2).

Non-linearity: ≤ ±0.5 % of span (BFSL, IEC 61298-2)

Long-term drift: ≤ ±0.2 % of span (IEC 61298-2)

### Accuracy, switching output

Switch point accuracy: ≤ ±1 % of span  
Adjustment accuracy: ≤ ±0.5 % of span

### Display

≤ ±1.0 % of span ± 1 digit

### Temperature error in rated temperature range

- typical: ≤ ±1.0 % of span
- maximum: ≤ ±2.5 % of span

### Temperature coefficients in rated temperature range

Mean TC zero point: ≤ ±0.2 % of span/10 K (typical)  
Mean TC span: ≤ ±0.1 % of span/10 K (typical)

## Reference conditions (per IEC 61298-1)

Temperature: 15 ... 25 °C (59 ... 77 °F)  
Atmospheric pressure: 950 ... 1,050 mbar (13.78 ... 15.23 psi)  
Humidity: 45 ... 75 % r. h.  
Nominal position: Process connection lower mount (LM)  
Power supply: DC 24 V  
Load: see output signals

## Operating conditions

### Permissible temperature ranges

Medium: -20 ... +85 °C (-4 ... +185 °F)

Ambient: -20 ... +80 °C (-4 ... +176 °F)

Storage: -20 ... +70 °C (-4 ... +158 °F)

Nominal temperature: 0 ... 80 °C (32 ... 176 °F)

### Humidity

45 ... 75 % r. h.

### Vibration resistance

10 g (IEC 60068-2-6, under resonance)

### Shock resistance

50 g (IEC 60068-2-27, mechanical)

### Service life, mechanics

100 million load cycles (10 million load cycles for measuring ranges > 600 bar/7,500 psi)

### Ingress protection

IP65 and IP67

The stated ingress protection (per IEC 60529) only applies when plugged in using mating connectors that have the appropriate ingress protection.

### Mounting position

as required

## Materials

### Wetted parts

Process connection: 316L

Pressure sensor: < 10 bar (150 psi): 316L  
≥ 10 bar (150 psi): PH steel

### Non-wetted parts

Case: 304

Keyboard: TPE-E

Display window: PC

Display head: PC+ABS-Blend

Pressure transmission medium:

Synthetic oil for all gauge-pressure measuring ranges < 10 bar (150 psi), all absolute-pressure measuring ranges and flush versions.

### Options for specific media

- Oil and grease free: Residual hydrocarbon: < 1,000 mg/m<sup>2</sup>  
Only available for PSD-30
- Oxygen, oil and grease free:  
Residual hydrocarbon: < 200 mg/m<sup>2</sup>  
Packaging: Protection cap on the process connection  
Max. permissible temperature -20 ... +60 °C (-4 ... +140 °F)  
Only available for PSD-30  
Available measuring ranges:  
0 ... 10 to 0 ... 400 bar (0 ... 150 to 0 ... 5,000 psi)  
-1 ... 9 to -1 ... 24 bar (-14.5 ... 160 to -14.5 ... 300 psi)  
Factory supplied without sealing

**Process connections****Available connections, model PSD-30**

Standard	Thread	Overload limit	Sealing
DIN 3852-E	G ¼ A	1,000 bar (14,500 psi)	NBR (options: without, FPM/FKM)
	G ½ A	1,000 bar (14,500 psi)	NBR (options: without, FPM/FKM)
EN 837	G ¼ B <sup>1)</sup>	1,000 bar (14,500 psi)	without (options: copper, stainless steel)
	G ¼ female	1,000 bar (14,500 psi)	-
	G ½ B <sup>1)</sup>	1,000 bar (14,500 psi)	without (options: copper, stainless steel)
ANSI/ASME B1.20.1	¼ NPT <sup>1)</sup>	1,000 bar (14,500 psi)	-
	½ NPT <sup>1)</sup>	1,000 bar (14,500 psi)	-
ISO 7	R ¼ <sup>1)</sup>	1,000 bar (14,500 psi)	-
KS	PT ¼ <sup>1)</sup>	1,000 bar (14,500 psi)	-
-	G ¼ female (Ermeto compatible)	1,000 bar (14,500 psi)	-

1) suitable for oxygen, oil and grease free.

Other connections on request.

**Available connections, model PSD-31**

Standard	Thread	Overload limit	Sealing
-	G ½ B with flush diaphragm	1,000 bar (14,500 psi)	NBR (options: FPM/FKM)

**Restrictor (option)**

For applications where pressure spikes can occur, the use of a restrictor is recommended. The restrictor narrows the pressure port to 0.3 mm and thus increases the resistance against pressure spikes.

## Electrical connections

### Connections

- Circular connector M12 x 1 (4-pin)
- Circular connector M12 x 1 (5-pin) <sup>1)</sup>

1) Only for version with two switching outputs and additional analogue signal

### Electrical safety

Short-circuit resistance: S+ / SP1 / SP2 vs. U-

Reverse polarity protection: U+ vs. U-

Insulation voltage: DC 500 V

Overvoltage protection: DC 40 V

### Connection diagram









Circular connector M12 x 1 (4-pin)		
	U+	1
	U-	3
	S+	2
	SP1 / C	4
	SP2	2

Circular connector M12 x 1 (5-pin)		
	U+	1
	U-	3
	S+	5
	SP1 / C	4
	SP2	2

### Legend:

- U+ Positive power supply
- U- Reference potential
- SP1 Switching output 1
- SP2 Switching output 2
- C Communication with IO-Link
- S+ Analogue output

## Approvals

Logo	Description	Country
	<b>EU declaration of conformity</b> <ul style="list-style-type: none"> <li>■ EMC directive EN 61326 emission (group 1, class B) and interference immunity (industrial application)</li> <li>■ Pressure equipment directive</li> <li>■ RoHS directive</li> </ul>	European Union
	<b>UL</b> Safety (e.g. electr. safety, overpressure, ...)	USA
	<b>EAC</b> <ul style="list-style-type: none"> <li>■ EMC directive</li> <li>■ Pressure equipment directive</li> </ul>	Eurasian Economic Community
	<b>GOST</b> Metrology, measurement technology	Russia
	<b>KazInMetr</b> Metrology, measurement technology	Kazakhstan
-	<b>MTSCHS</b> Permission for commissioning	Kazakhstan
	<b>BelGIM</b> Metrology, measurement technology	Belarus
	<b>UkrSEPRO</b> Metrology, measurement technology	Ukraine
	<b>Uzstandard</b> Metrology, measurement technology	Uzbekistan
-	<b>CRN</b> Safety (e.g. electr. safety, overpressure, ...)	Canada

## Manufacturer's information and certifications

Logo	Description
-	China RoHS conformity
-	MTTF > 100 Jahre

Approvals and certificates, see website

**Dimensions in mm (inch)**

Pressure switch with circular connector M12 x 1 (4-pin and 5-pin)

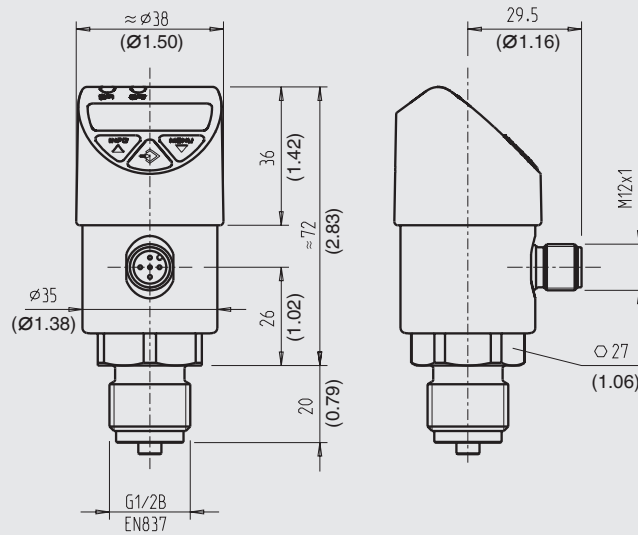

Weight: approx. 220 g (7.76 oz)

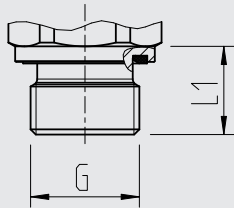

G	L1
G ¼ A DIN 3852-E	14 (0.55)
G ½ A DIN 3852-E	17 (0.67)

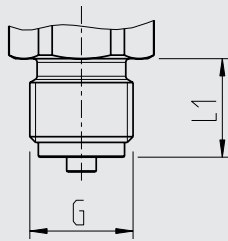

G	L1
G ¼ B EN 837	13 (0.51)
G ½ B EN 837	20 (0.79)

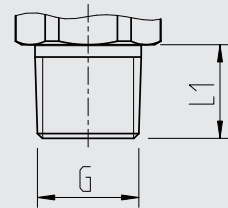

G	L1
¼ NPT	13 (0.51)
½ NPT	19 (0.75)
R ¼	13 (0.51)
PT ¼	13 (0.51)

Female thread

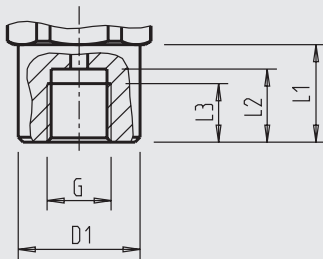

G	L1	L2	L3	D1
G ¼ <sup>1)</sup>	20 (0.79)	15 (0.59)	12 (0.47)	Ø 25 (Ø 0.98)

Female thread

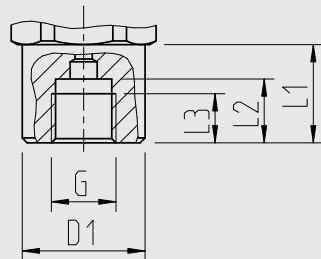

G	L1	L2	L3	D1
G ¼ EN 837	20 (0.79)	13 (0.51)	10 (0.39)	Ø 25 (Ø 0.98)

Flush

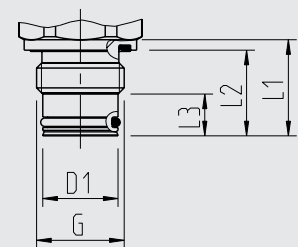



G	L1	L2	L3	D1
G ½ B <sup>2)</sup>	23 (0.91)	20,5 (0.81)	10 (0.39)	Ø 18 (Ø 0.71)

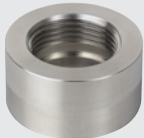

1) Ermeto compatible

2) Welding sockets recommended as defined counter-thread (see accessories)



Welding socket		
	Description	Order no.
	G ½ B female, outer diameter 50 mm (2 in), material 1.4571	1192299

Sealings		
	Description	Order no.
	NBR profile sealing G ¼ A DIN 3852-E	1537857
	FPM/FKM profile sealing G ¼ A DIN 3852-E	1576534
	NBR profile sealing G ½ A DIN 3852-E	1039067
	FPM/FKM profile sealing G ½ A DIN 3852-E	1039075
	Copper G ¼ B EN 837	11250810
	Stainless steel G ¼ B EN 837	11250844
	Copper G ½ B EN 837	11250861
	Stainless steel G ½ B EN 837	11251042

Connectors with moulded cable				
	Description	Temperature range	Cable diameter	Order no.
	Straight version, cut to length, 4-pin, 2 m (6.6 ft) PUR cable, UL listed, IP67	-20 ... +80 °C (-4 ... +176 °F)	4.5 mm (0.18 in)	14086880
	Straight version, cut to length, 4-pin, 5 m (16.4 ft) PUR cable, UL listed, IP67	-20 ... +80 °C (-4 ... +176 °F)	4.5 mm (0.18 in)	14086883
	Straight version, cut to length, 4-pin, 10 m (32.8 ft) PUR cable, UL listed, IP67	-20 ... +80 °C (-4 ... +176 °F)	4.5 mm (0.18 in)	14086884
	Straight version, cut to length, 5-pin, 2 m (6.6 ft) PUR cable, UL listed, IP67	-20 ... +80 °C (-4 ... +176 °F)	5.5 mm (0.22 in)	14086886
	Straight version, cut to length, 5-pin, 5 m (16.4 ft) PUR cable, UL listed, IP67	-20 ... +80 °C (-4 ... +176 °F)	5.5 mm (0.22 in)	14086887
	Straight version, cut to length, 5-pin, 10 m (32.8 ft) PUR cable, UL listed, IP67	-20 ... +80 °C (-4 ... +176 °F)	5.5 mm (0.22 in)	14086888
	Angled version, cut to length, 4-pin, 2 m (6.6 ft) PUR cable, UL listed, IP67	-20 ... +80 °C (-4 ... +176 °F)	4.5 mm (0.18 in)	14086889
	Angled version, cut to length, 4-pin, 5 m (16.4 ft) PUR cable, UL listed, IP67	-20 ... +80 °C (-4 ... +176 °F)	4.5 mm (0.18 in)	14086891
	Angled version, cut to length, 4-pin, 10 m (32.8 ft) PUR cable, UL listed, IP67	-20 ... +80 °C (-4 ... +176 °F)	4.5 mm (0.18 in)	14086892
	Angled version, cut to length, 5-pin, 2 m (6.6 ft) PUR cable, UL listed, IP67	-20 ... +80 °C (-4 ... +176 °F)	5.5 mm (0.22 in)	14086893
	Angled version, cut to length, 5-pin, 5 m (16.4 ft) PUR cable, UL listed, IP67	-20 ... +80 °C (-4 ... +176 °F)	5.5 mm (0.22 in)	14086894
	Angled version, cut to length, 5-pin, 10 m (32.8 ft) PUR cable, UL listed, IP67	-20 ... +80 °C (-4 ... +176 °F)	5.5 mm (0.22 in)	14086896

**Cooling element for screwing G ½ female / G ½ male per EN 837  
(for instruments with process connection G ½ B per EN-837)**

	Description	Order no.
	Max. medium temperature 150 °C (302 °F) at an ambient temperature of max. 30 °C (86 °F) Max. operating pressure 600 bar (8,700 psi)	14109813
	Max. medium temperature 200 °C (392 °F) at an ambient temperature of max. 30 °C (86 °F) Max. operating pressure 600 bar (8,700 psi)	14109815

**Instrument mounting bracket**

	Description	Order no.
	Instrument mounting bracket for PSD-30, aluminium, wall mounting	11467887

**OBSOLETE**

**Ordering information**

Model / Measuring range / Output signal / Process connection / Accessories and spare parts

© 04/2009 WIKA Alexander Wiegand SE & Co. KG, all rights reserved.  
The specifications given in this document represent the state of engineering at the time of publishing.  
We reserve the right to make modifications to the specifications and materials.

